

420 / 421

NON INSULATED INSULATED



Short Recessed Panel 24 Gauge

CARRIAGE HOUSE PANELS

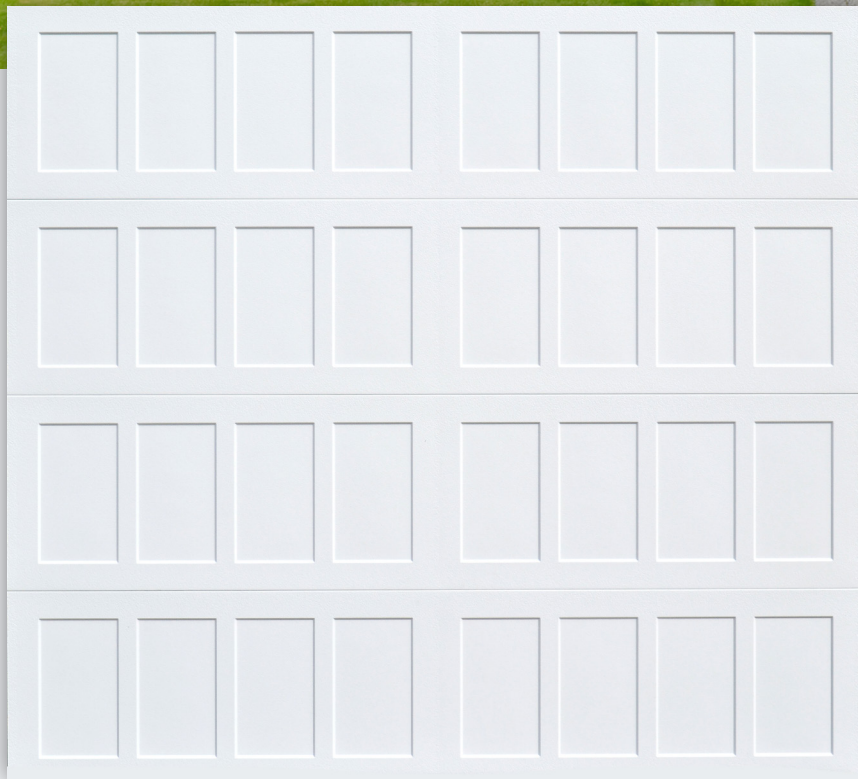

↑ WHITE

Short Recessed Panel

Constructed of top quality materials, highly detailed short recessed panel, deep pebble grain texture, and two coat prefinished paint system all combine to enhance the beauty of your home.

- 24 gauge steel
- 1.0 mil paint with 9 color options
- 6 window options
- R-value 6.85 **421 Feature*
- Vinyl interior skin **421 Feature*

↑ WHITE



WHITE



ALMOND



DESERT TAN



SANDSTONE



BROWN



GRAY



BLACK

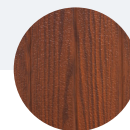

WALNUT

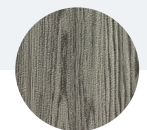

DRIFTWOOD

**Colors may vary from actual product*

FEATURES

24 GAUGE STEEL
Hot dipped galvanized steel construction with hemmed inside return rail provides superior strength and durability.

ROLLED SAFETY EDGES ON SECTION JOINTS
Eliminates sharp edges, and provides extra strength.

19 GAUGE HOT DIPPED GALVANIZED STILES
Heavy duty metal stiles give strong rigid support for all hinges, rollers, and operator attachment.

STILES ATTACHED WITH RIVETS
Provides superior strength when compared to common sheet metal joining methods.

TONGUE AND GROOVE MEETING RAILS
For superior strength and better sealing against wind, rain, and snow.

RIGID ALUMINUM RETAINER WITH WEATHERSTRIP
Provides added strength while securing replaceable U-type bottom astragal weatherstrip to help keep the elements out.

DIRECTIONAL WOOD GRAIN PATTERN
Directional wood grain pattern gives the appearance of traditional wood doors.

R-VALUE 6.85
Enhances your home's energy savings, makes your door operation quieter, and reduces exterior noise in your garage.
**421 Feature*

HIGH IMPACT PLASTIC BACK COVER
Protects the insulation, and enhances the interior look of your garage door.
**421 Feature*

CFC FREE EXPANDED POLYSTYRENE
Environmentally friendly insulation that will not degrade with vibration or time.
**421 Feature*

SIZE OPTIONS

WIDTHS:

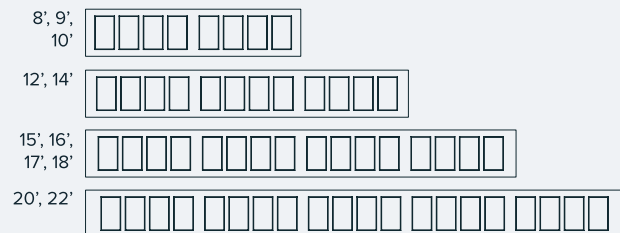

HEIGHTS: 6'6", 6'9", 7'0", 7'6", 7'9", 8'0"

WINDOW OPTIONS

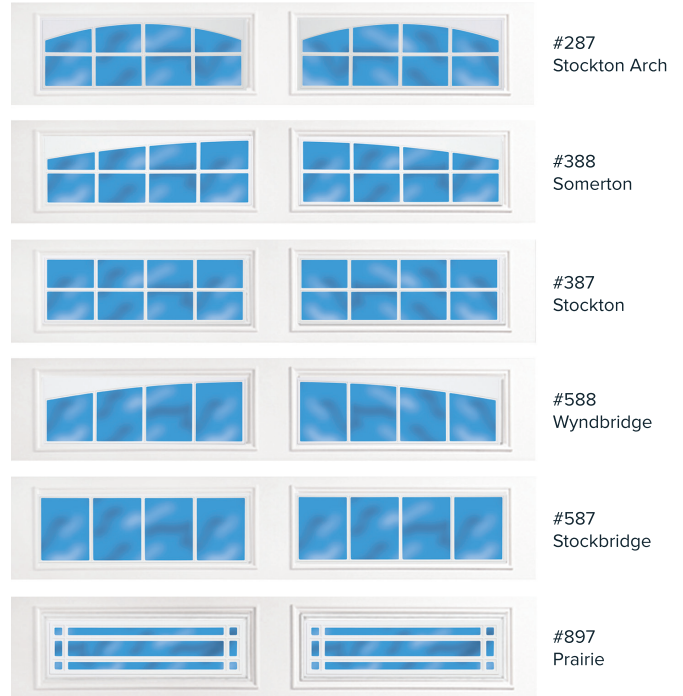

WINDOW GLASS OPTIONS

See website for glass options

**Not all glazing options may be available from all distributors. No glazing on 18" sections. Not all window inserts align with panel stamp design.*

PAINT LAYERS

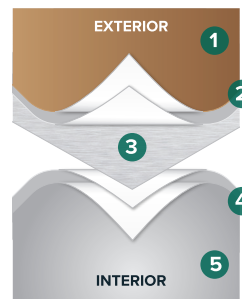

1.0 MIL PAINT SYSTEM

Includes .25 mil rust inhibiting primer and .75 mil exterior top coat that resists fading and chalking, while providing consistent color from panel to panel and more durability.

- 1 Paint - .75 MIL
- 2 Primer - .25 MIL
- 3 Steel
- 4 Primer - .2 MIL
- 5 Paint - .3 MIL

CONSTRUCTION

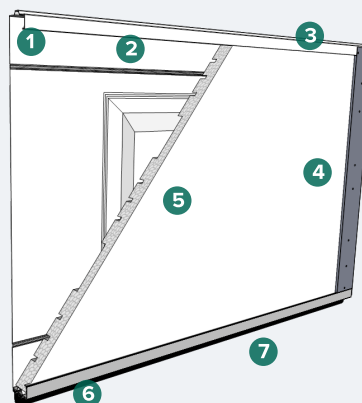

- 1 Tongue and groove meeting rails
- 2 Hemmed interior rails
- 3 2" thick section
- 4 19 gauge hot dipped galvanized steel stiles
- 5 CFC free expanded polystyrene insulation with vinyl backing (standard on 421)
- 6 Replaceable U-Type vinyl bottom weatherstrip
- 7 Extruded aluminum weatherstrip retainer

**This image is showing 421*